



ALPHA HOUSE powered by MONBAT®

2MVR400 TOP TERMINAL AGM VRLA

PRODUCT CHARACTERISTICS:

- Valve-regulated lead-acid battery
- Stationary and reserve power applications
- EUROBAT design life definition: Very Long Life 12+ years
- Extremely long float life performance
- Superior cycling endurance
- Compact design with high energy density
- ETSI Rack integration
- Low installation cost, maintenance free product
- Sealed for leak-proof operation
- Delivered ready for use
- Non-hazardous cargo for ground, sea and air transport
- Fully recyclable product



TECHNICAL SPECIFICATIONS:

Electrical specifications:	
Nominal voltage:	2V
Number of cells:	1
Rated capacity:	400 Ah (10 h rate to 1.80 Vpc at 20 °C)
Internal resistance:	0.39 mOhm (IEC 60 896 -21/22)
Short circuit current:	5 330 A (IEC 60 896 -21/22)
Float charge voltage:	2.27 V per cell (Vpc) at 20 °C
Design features:	
Design life at 20 °C:	Very Long Life 12+ years
Plates:	Tick Flat Pasted
Active material:	Very high purity virgin lead
Grid alloy:	Lead-Calcium-Tin alloy
Electrolyte:	Sulphuric acid, Analytical grade
Separator:	Absorbing Glass Mat (AGM)
Operating temperature:	-20 °C to +60 °C +15 °C to +25 °C (recommended)
Venting valve:	Rubber, one way, self resealing - Opening pressure: 1.7 PSI - Resealing pressure: 1.5 PSI
Internal gas recombination efficiency:	more than 99%
Flame arrestor:	Available
Central degassing system	Available
Storage temperatures:	-20 °C to +40 °C
Self discharge:	Less than 2.0% per month at 20°C
Storability without recharging:	Up to 6 months at 20°C
Shelf life:	Up to 1 year
Container / lid material:	Shock resistant ABS FR; flammability class UL94 V0
Terminal position:	Top
Terminal sealing:	Mechanical + epoxy double sealing
Terminal type:	Brass; Female; M8 thread
Terminal torque:	7 Nm
Transport terminal cover:	Available
Carrying Handles:	Available (2)
Connectors and bolts:	Supplied as standard
Applicable standards and recommendations:	
IEC 60896 - 21/22; EN 50272 - 2; IEC 61427 - 1/2; IEC 61056 - 1; IEEE 1184; IEEE 1187; IEEE 1188	
Manufacture standards:	
ISO 9001; ISO 14001; OHSAS 18001; AQAP 2110	

PHYSICAL CHARACTERISTICS:

	SI Units	US Units
Length	389 mm	15.31 inches
Width	171 mm	6.73 inches
Height	238 mm	9.37 inches
Weight	29.2 kg	64.4 lbs

DRAWINGS:

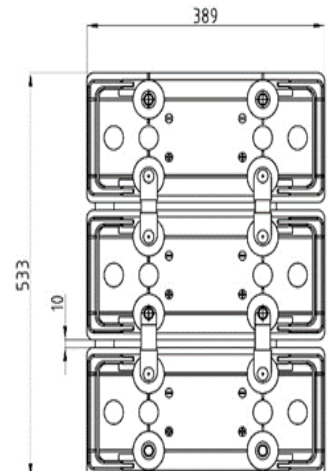
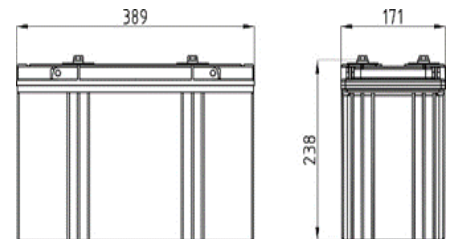



PERFORMANCE CHARACTERISTICS

DISCHARGE PERFORMANCE AT CONSTANT CURRENT DISCHARGE (AH) FOR BATTERY 2MVR400 AT 20°C

Uf, Vpc	5 min	15 min	30 min	1h	2h	3h	4h	5h	6h	8h	10h	20h
1.6	84.0	144.0	206.0	251.2	292.4	321.2	342.0	358.4	370.8	395.6	412.0	440.8
1.65	83.0	144.0	205.0	250.0	291.2	320.0	340.4	356.8	369.2	393.6	410.0	438.4
1.7	82.0	143.0	204.0	248.8	289.6	318.4	338.8	354.8	367.2	391.6	408.0	436.4
1.75	81.0	142.0	202.0	246.4	286.8	315.2	335.2	351.6	363.6	388.0	404.0	432.0
1.8	80.0	140.0	200.0	244.0	284.0	312.0	332.0	348.0	360.0	384.0	400.0	428.0
1.85	78.0	136.0	195.0	238.0	276.8	304.0	324.0	339.2	351.2	374.4	390.0	417.2

DISCHARGE PERFORMANCE AT CONSTANT CURRENT DISCHARGE (A) FOR BATTERY 2MVR400 AT 20°C

Uf, Vpc	5 min	15 min	30 min	1h	2h	3h	4h	5h	6h	8h	10h	20h
1.6	1013.0	576.0	412.0	251.2	146.2	107.1	85.5	71.7	61.8	49.5	41.2	22.0
1.65	996.0	574.0	410.0	250.0	145.6	106.7	85.1	71.4	61.5	49.2	41.0	21.9
1.7	980.0	571.0	408.0	248.8	144.8	106.1	84.7	71.0	61.2	49.0	40.8	21.8
1.75	970.0	566.0	404.0	246.4	143.4	105.1	83.8	70.3	60.6	48.5	40.4	21.6
1.8	960.0	560.0	400.0	244.0	142.0	104.0	83.0	69.6	60.0	48.0	40.0	21.4
1.85	936.0	546.0	390.0	238.0	138.4	101.3	81.0	67.8	58.5	46.8	39.0	20.9

DISCHARGE PERFORMANCE AT CONSTANT POWER DISCHARGE W (PER CELL) FOR BATTERY 2MVR400 AT 20°C

Uf, Vpc	5 min	15 min	30 min	1h	2h	3h	4h	5h	6h	8h	10h	20h
1.6	2026.0	1152.0	824.0	502.4	292.4	214.2	171.0	143.4	123.6	98.9	82.4	44.1
1.65	1968.0	1149.0	821.0	500.0	291.2	213.4	170.2	142.7	123.0	98.4	82.0	43.8
1.7	1954.0	1142.0	816.0	497.6	289.6	211.2	169.4	141.9	122.4	97.9	81.6	43.6
1.75	1939.0	1133.0	808.0	492.8	286.8	209.0	167.6	140.6	121.2	96.6	80.8	43.2
1.8	1920.0	1120.0	800.0	488.0	284.0	208.0	166.0	139.2	120.0	96.0	80.0	42.8
1.85	1872.0	1091.0	781.0	476.0	276.8	202.6	162.0	135.7	117.0	93.6	78.0	41.7

TEMPERATURE CORRECTION FACTOR OF CAPACITY AT CONSTANT CURRENT DISCHARGE

Discharge time	-10 °C	0 °C	10 °C	15 °C	20 °C	25 °C	30 °C	35 °C	40 °C	45 °C
From 5 to 59 minutes	0.70	0.80	0.90	0.95	1.00	1.05	1.10	1.13	1.15	1.16
From 1 to 20 hours	0.82	0.88	0.94	0.97	1.00	1.03	1.05	1.07	1.08	1.10

BATTERY CHARGE CONDITIONS AT 20° CONSTANT VOLTAGE AND LIMITED CURRENT (IU)

Charge current limit	Float charge voltage	Equalization charge voltage	Boost charge voltage
0.1 – 0.25C ₁₀ A Recommended: 0.20C ₁₀ A	2.27 V per cell at 20 °C; Temperature correction:-3mV / cell / °C	2.32 V per cell at 20 °C Recommended: every 3 months for 24h during long time float operation	2.40 V per cell at 20°C; Temperature correction:-4mV / cell / °C

Float application: 0.20C₁₀ A / 2.27 V per cell at 20 °C

Cycling applications: 0.20C₁₀ A / 2.40 V per cell at 20 °C
Recharge Ah input at least 105% from previous discharge Ah

