



ALPHA HOUSE

intelligent power

AH12-7 (12V-7Ah) VRLA AGM



Outer Dimensions (mm)

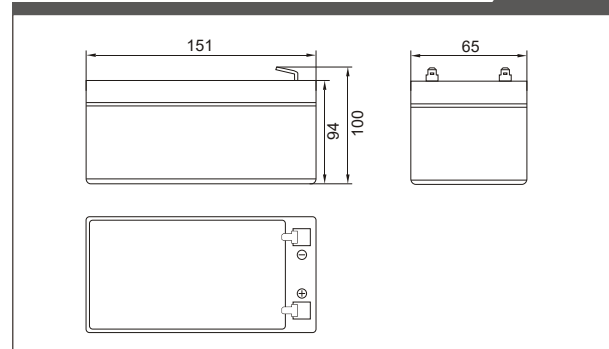

Specifications

Nominal Voltage		12V
Rated capacity (20 hour rate)		7.0Ah
Dimensions	Total Height	100mm (3.94 inches)
	Height	94mm (3.70 inches)
	Length	151mm (5.94 inches)
	Width	65mm (2.56 inches)
Approx. Weight		2.05Kg (4.53lbs)
Terminal		T1

Terminal Type (mm)

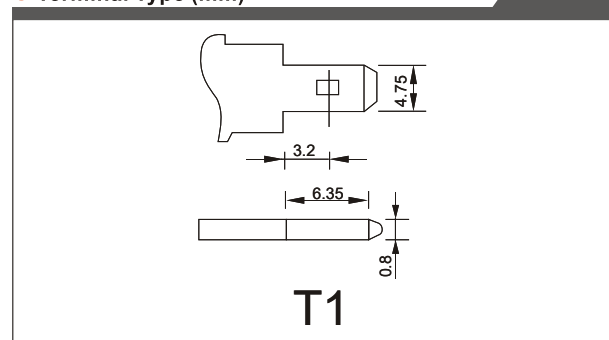

Characteristics

Capacity 25°C(77°F)	20 hour rate(0.35 A)	7.00 AH
	10 hour rate(0.64 A)	6.40 AH
	5 hour rate(1.20 A)	6.00AH
	1 hour rate(4.20 A)	4.20 AH
1.5 hour discharge to 10.5V		2.8 A
Internal Resistance	Full charged Battery at 25°C(77°F)	31 m Ω
Capacity affected by Temperature (20hour rate)	40°C(104°F)	102%
	25°C(77°F)	100%
	0°C(32°F)	85%
Self-Discharge at 25°C(77°F)	Capacity after 3 month storage	91%
	Capacity after 6 month storage	82%
	Capacity after 12 month storage	64%
Charge (constant Voltage)	Cycle	Initial Charging Current less than 2.1 A. Voltage 14.10-14.40V
	Float	Voltage 13.50-13.80V
Design Life		5~7 Years(Float charging)

Construction

Component	Positive plate	Negative plate	Container	Cover
Raw material	Lead dioxide	Lead	ABS (V0/HB)	ABS (V0/HB)
Component	Separator	Electrolyte	Safety valve	Terminal
Raw material	AGM	Sulfuric acid	Rubber	Cu coated by Ag

Product Compliance

IEC: 60896-21/22:2004; UL: MH26669;
 GB/T: 19639-2014; BS: 6290 part 4;
 JIS: CB704-1:2006; EUROBAT; CE

Manufacturer's Certificates

ISO: 9001:2005
 ISO: 14001:2015
 OHSAS: 18001:2007

Constant Current(Amp) and Constant Power(Watt) Discharge Table at 25°C(77°F)

Time		5min	10min	15min	30min	1h	2h	3h	4h	5h	8h	10h	20h
9.60V	A	25.2	16.5	12.3	8.05	4.20	2.45	1.80	1.45	1.23	0.81	0.66	0.36
	W	297.2	186.7	141.2	85.5	48.4	28.4	20.85	16.74	14.20	9.36	7.67	4.20
10.20V	A	23.1	15.8	11.3	7.64	3.94	2.35	1.75	1.40	1.20	0.80	0.65	0.35
	W	279.7	176.8	132.7	84.9	45.5	27.2	20.27	16.22	13.94	9.22	7.53	4.08
10.50V	A	21.0	14.8	10.5	7.41	3.82	2.30	1.72	1.33	1.20	0.79	0.64	0.35
	W	270.1	171.5	126.9	84.0	44.2	26.7	19.92	15.40	13.85	9.13	7.47	4.05
10.80V	A	20.2	14.1	9.80	7.20	3.69	2.25	1.69	1.31	1.14	0.77	0.63	0.35
	W	236.8	166.3	122.2	83.7	42.9	26.1	19.69	15.21	13.24	8.75	7.29	3.97
11.10V	A	18.7	13.3	9.10	7.00	3.56	2.19	1.60	1.28	1.09	0.75	0.61	0.33
	W	229.0	160.7	116.4	83.1	42.3	26.0	19.10	15.17	12.95	8.46	7.15	3.94



● **Charging Characteristics(25°C)**

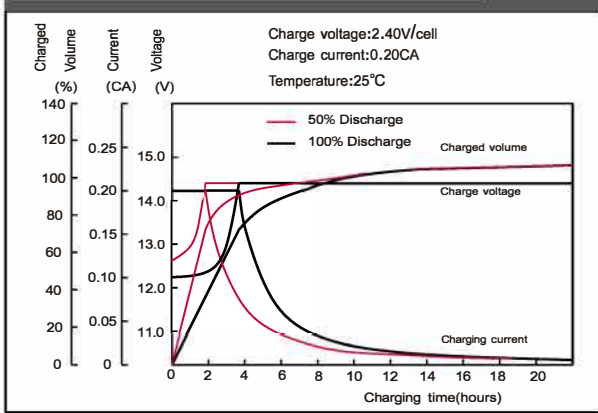

● **Cycle Life In Relation To Depth Of Discharge**

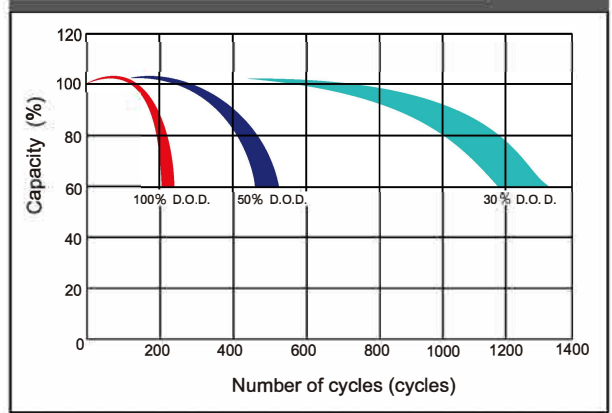

● **Discharge Characteristics Curve**

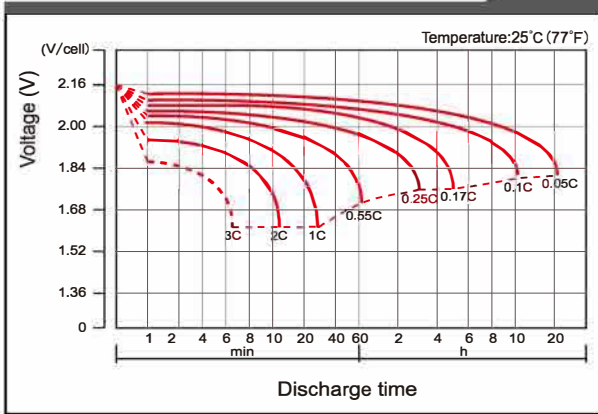

● **The Relationship of OCV and Capacity (25°C)**

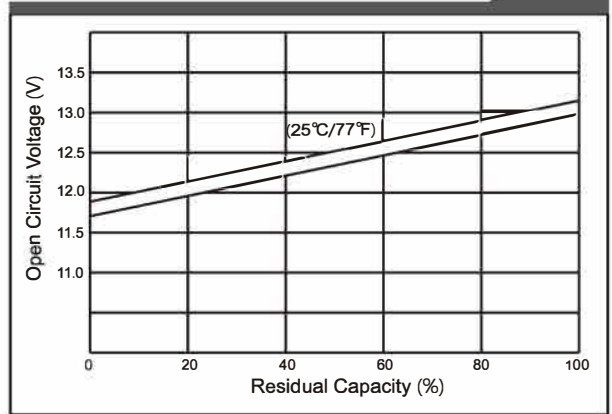

● **Floating Life On Temperature**

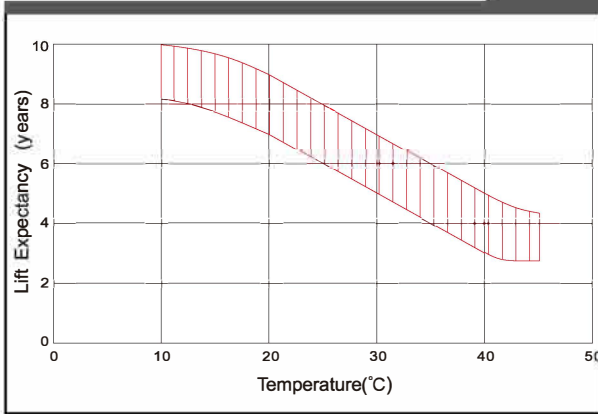

● **Self-Discharge Characteristics**

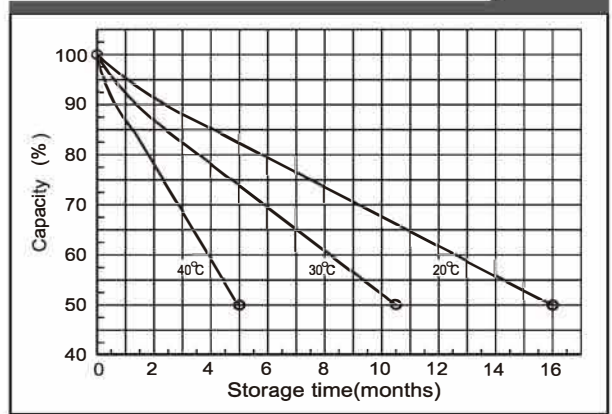

● **Charging Voltage VS Temperature**

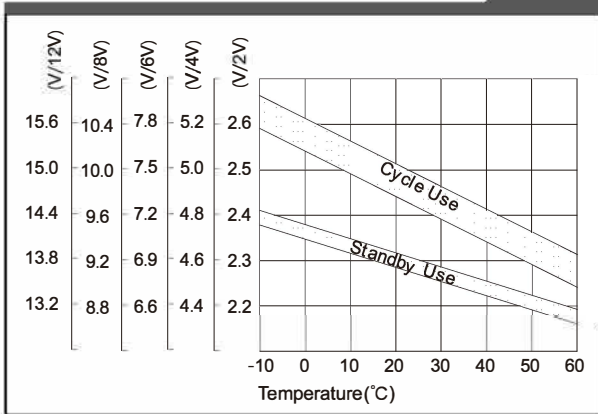

● **Temperature Effects On Capacity**

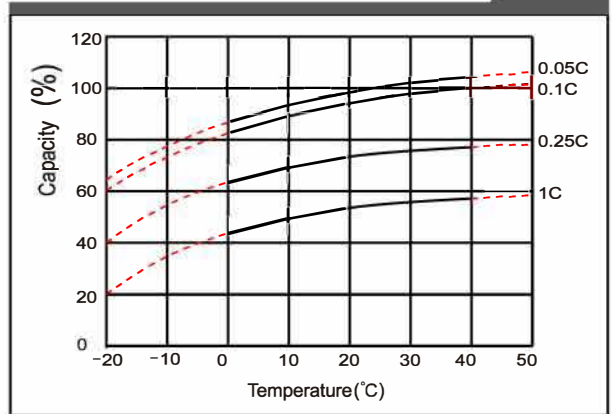

Disclaimer: The manufacturer reserves the right to amend and/or vary the specifications and parameters of the product and apply updates accordingly at any time. It is the sole responsibility of the buyer and user of the product to ensure all applicable product specifications referred to are valid and up to date. All product specifications are available upon request. Batteries must be installed in accordance with standard BS EN IEC 62485-2:2018, and in accordance with manufacturer's guidelines. (available upon request)

